

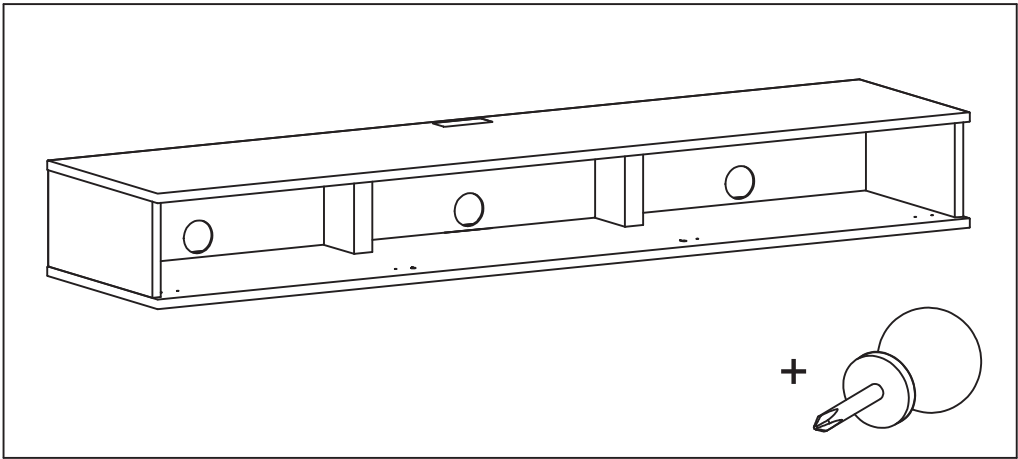

unnu 130S

Version 1.2



Herunder følger manualer for det mest anvendte unnu tilbehør. **Ikke inkluderet.** Alle unnu manualer kan ses på unnu.nu
*Below you see manuals for the most used unnu accessories. **NOT included.** All unnu manuals can be found on unnu.nu*
 Unten folgen Bedienungsanleitungen für das meistverwendete unnu Zubehör. **Nicht inbegriffen.** Alle unnu Bedienungsanleitungen finden Sie unter unnu.nu

Alu Cover

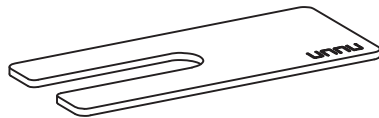

A x 1



B x 2

1

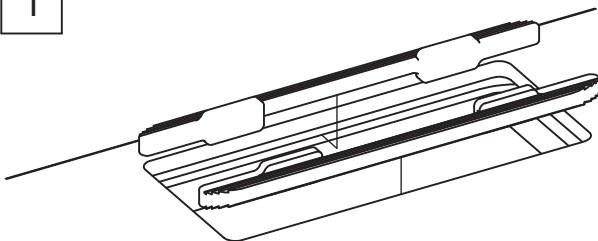

1.1

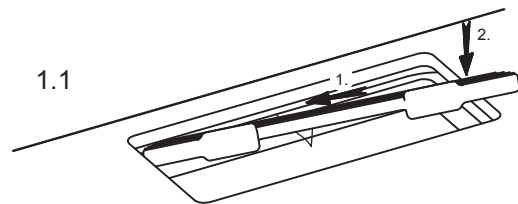

1.2

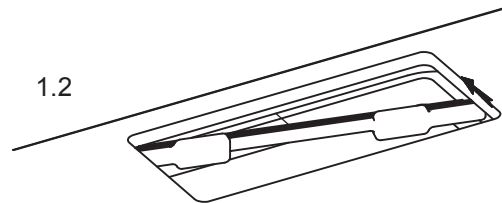

1.3

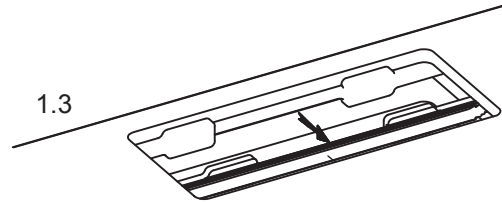

2

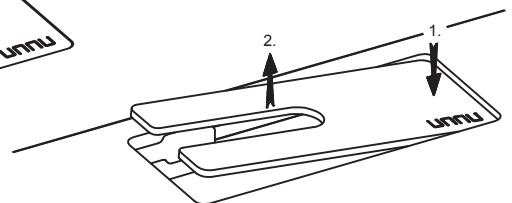
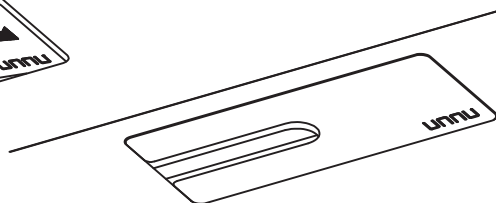
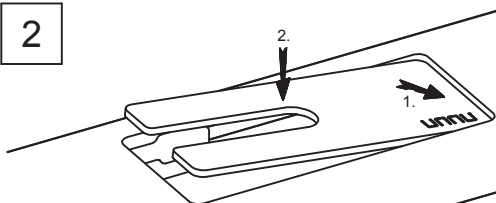

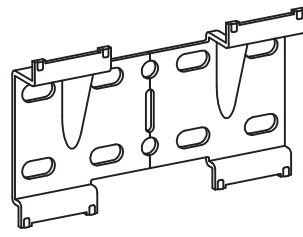
Wallbracket 3

A x 2

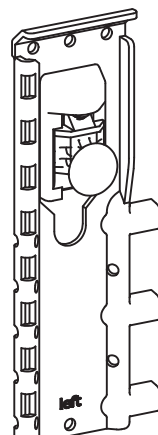

B x 2

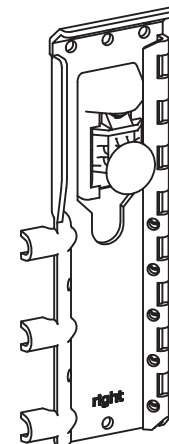

C x 2



D x 20

Nødvendige beslag
(Ikke inkluderet)

*Fittings needed
(Not included)*

Benötigte Beschläge
(Nicht im Lieferumfang
enthalten)



E x 8



F x 8

Skruer og rawlplugs afhænger af vægtype, spørg en fagmand.

Screws and plugs depends on the type of wall, ask a professional.

Schrauben und Dübel müssen den baulichen Voraussetzungen angepasst werden. Fragen Sie einen Fachmann.

Nødvendigt værktøj

Tools needed

Benötigte Werkzeuge

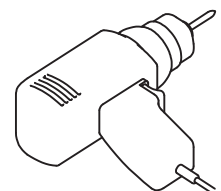
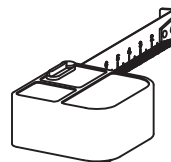
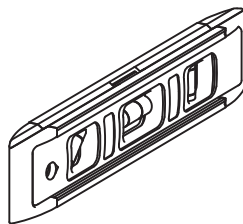
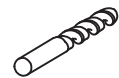
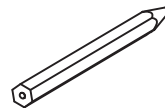
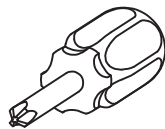

Maksimal belastning

Maximum Load

Maximale Belastung

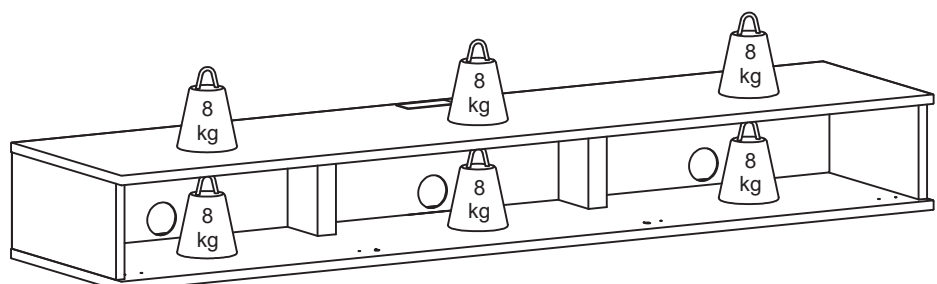

1

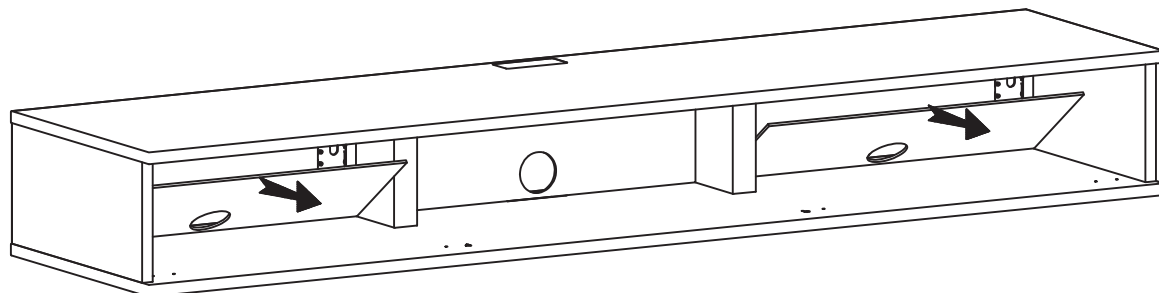

2

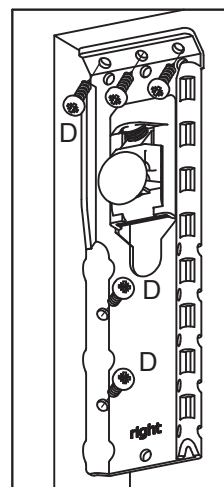
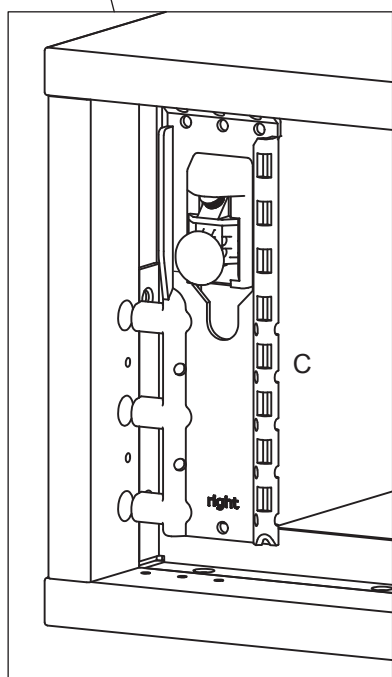
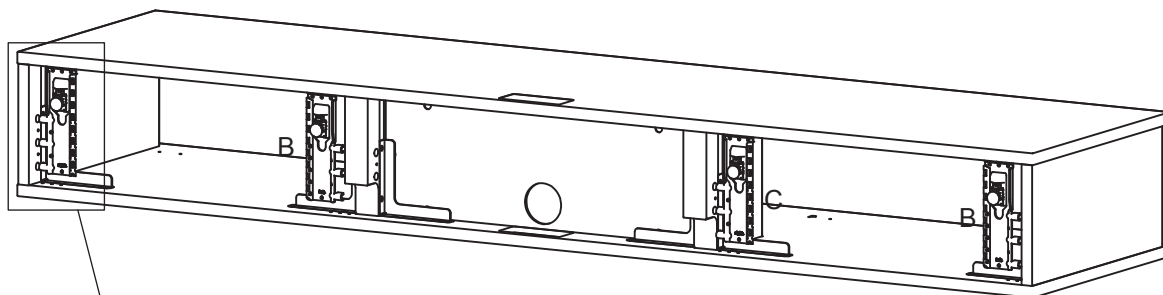

Pas på ikke at overspænde skruerne.
Be careful not to over-tighten the screws.
 Achten Sie darauf, die Schrauben nicht
 zu stark anzuziehen.

3

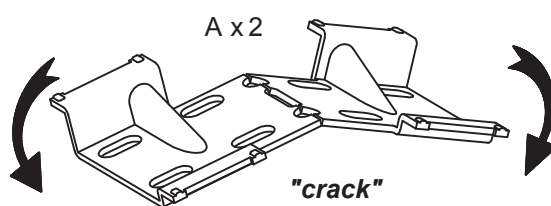

4

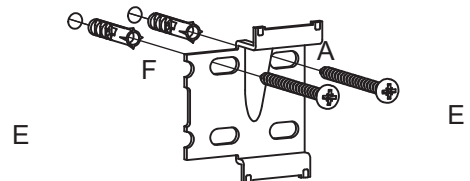
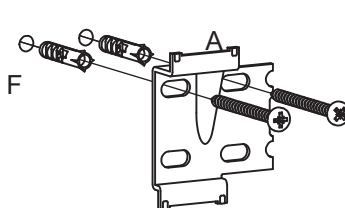
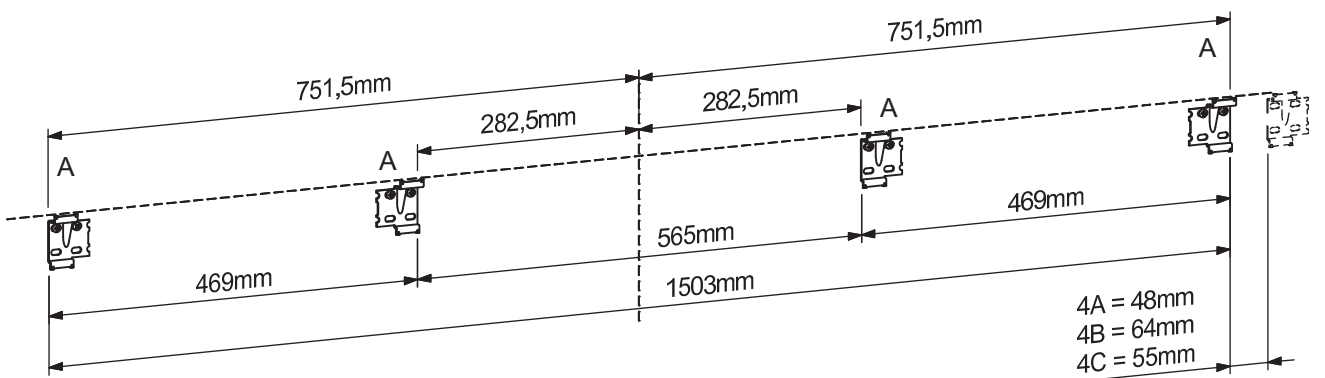
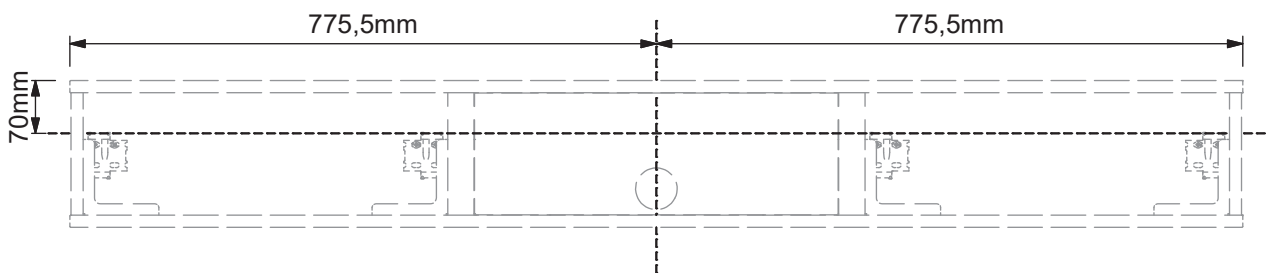
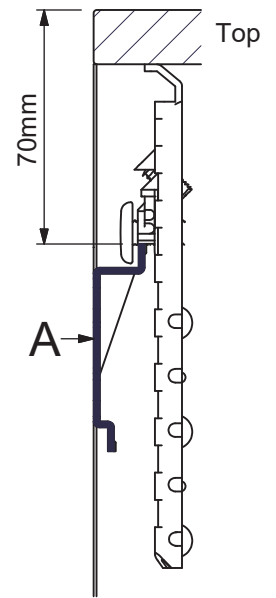
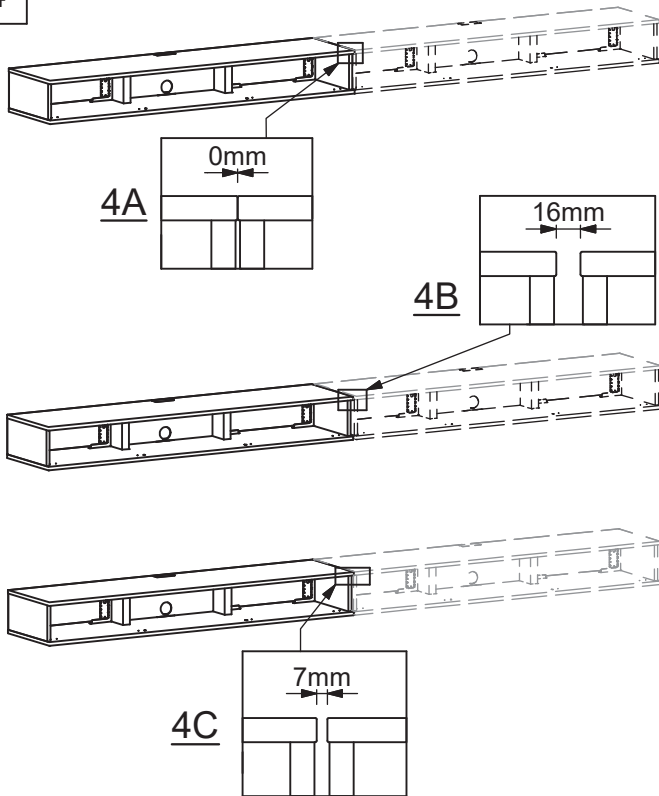

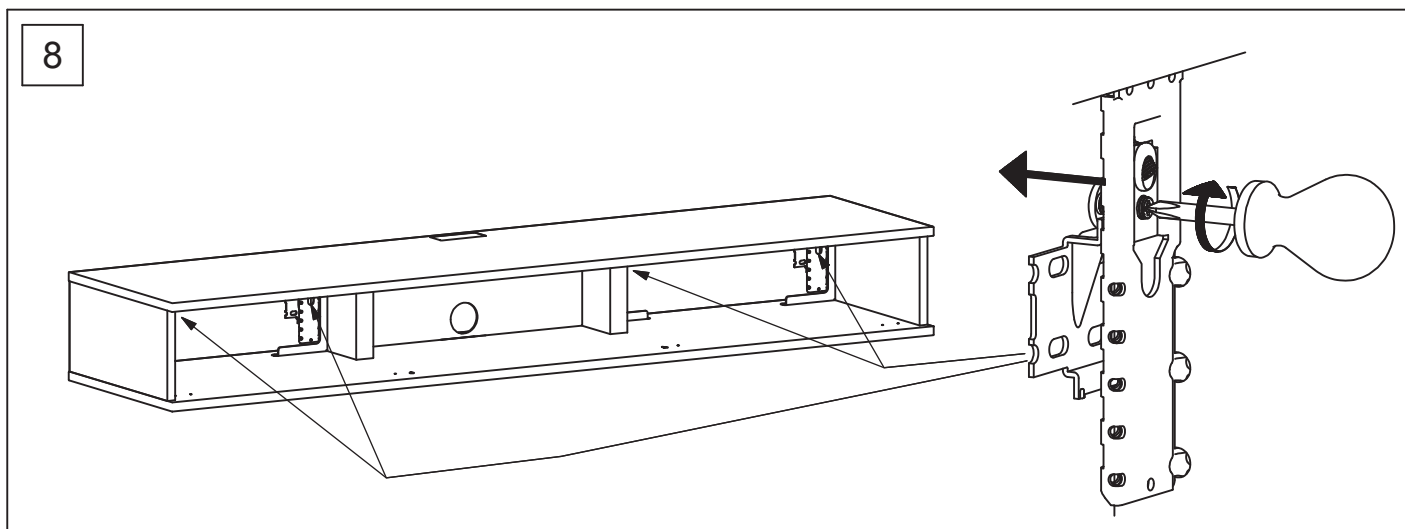
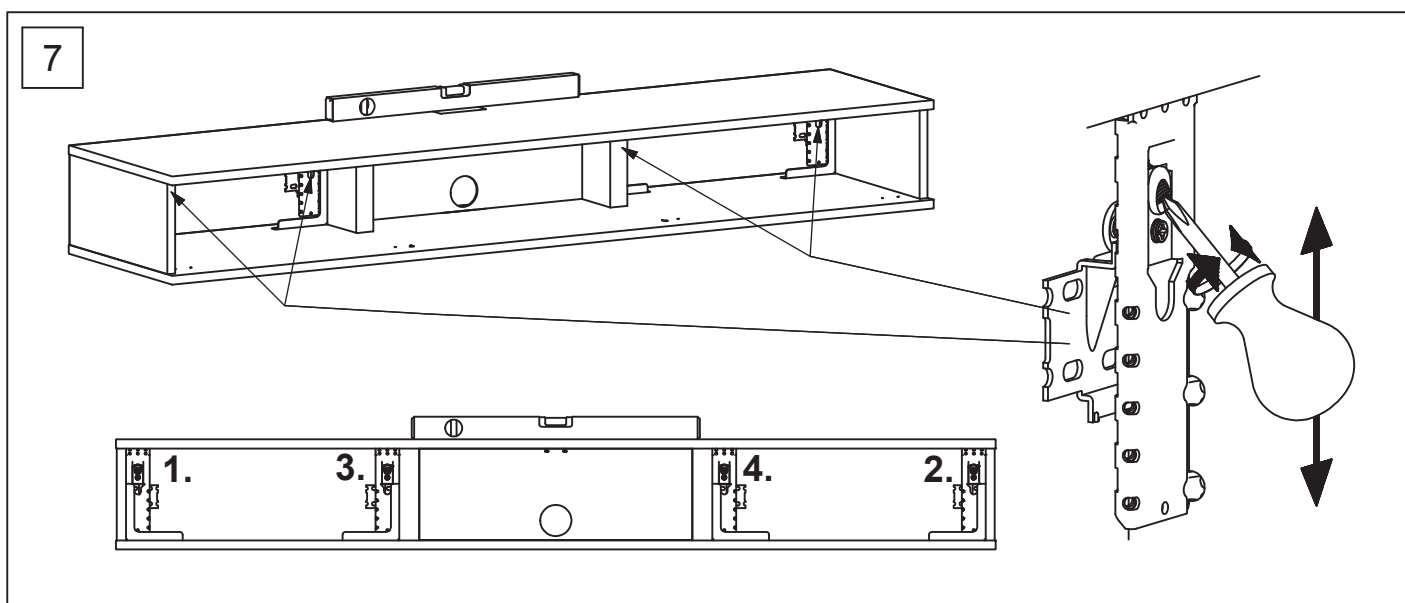
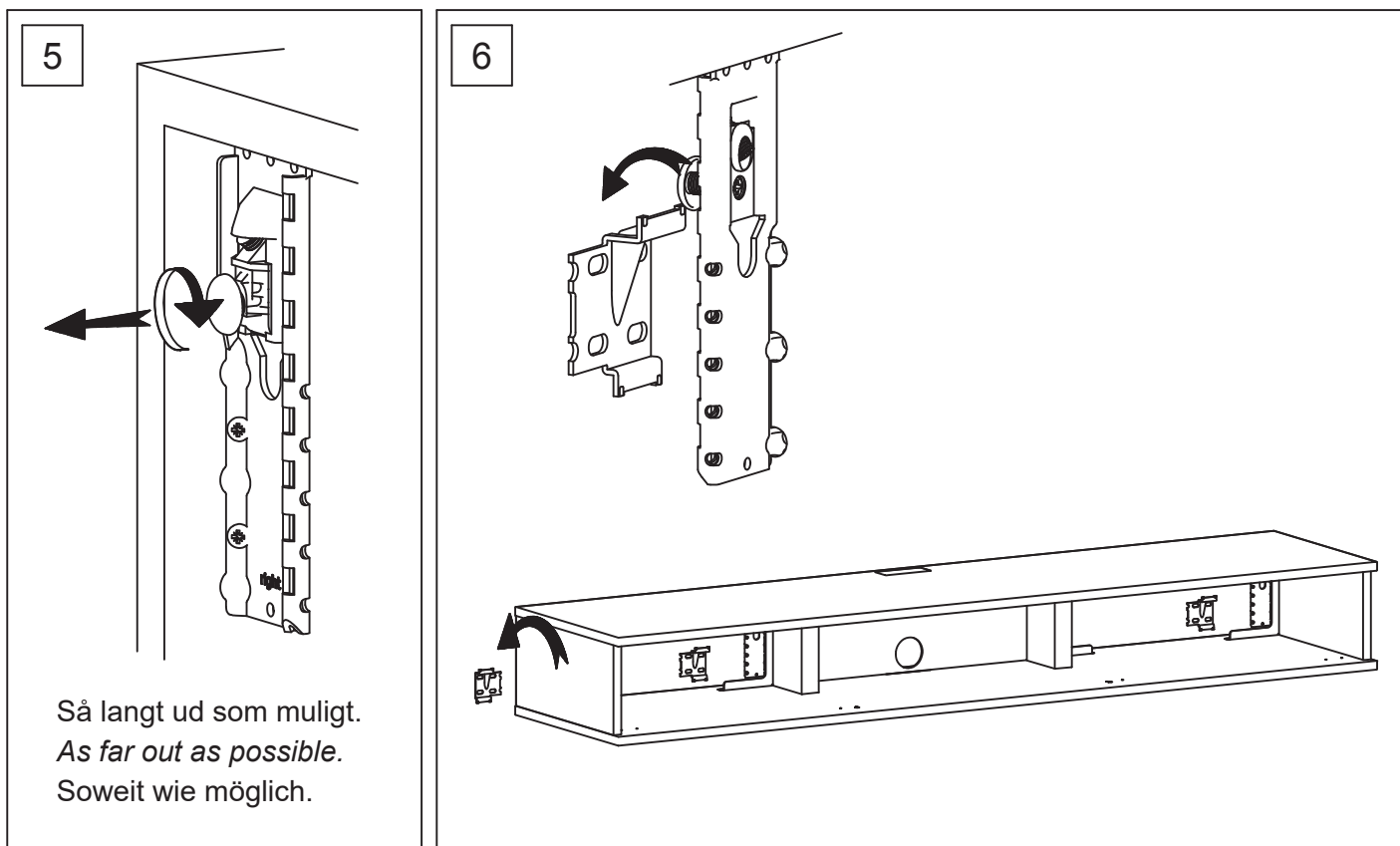

unnu Door

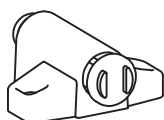
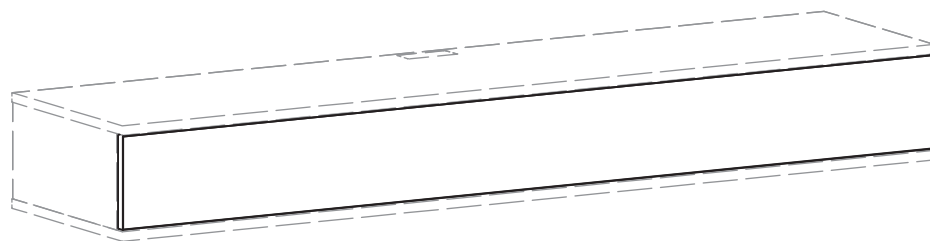

A x 1



B x 3

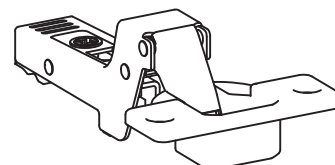

C x 3



D x 12



E x 2



F x 2

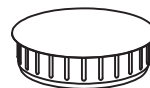

G x 2

Nødvendigt værktøj
Tools needed
Benötigte Werkzeuge

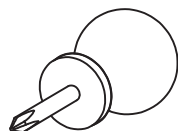

1

