

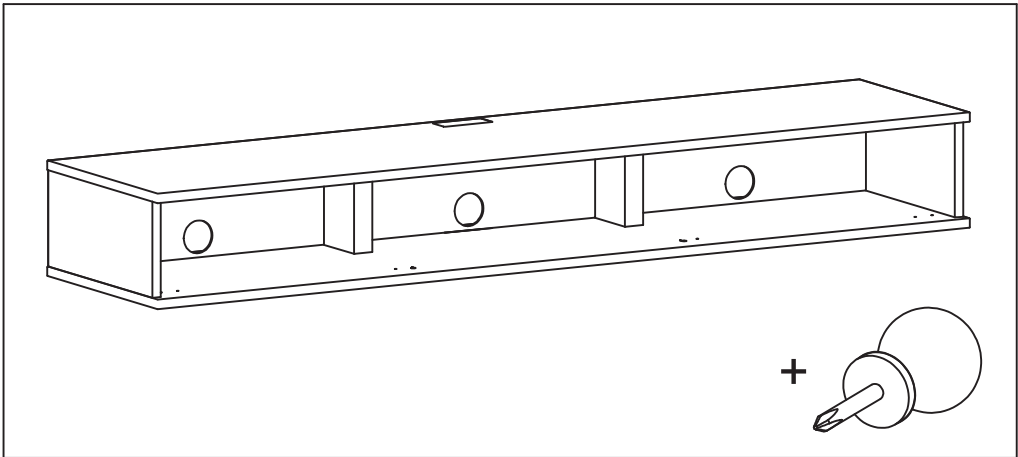

unnu 130S

Version 1.1



Herunder følger manualer for det mest anvendte unnu tilbehør. **Ikke inkluderet.** Alle unnu manualer kan ses på unnu.nu
Below you see manuals for the most used unnu accessories. NOT included. All unnu manuals can be found on unnu.nu
 Unten folgen Bedienungsanleitungen für das meistverwendete unnu Zubehör. **Nicht inbegriffen.** Alle unnu Bedienungsanleitungen finden Sie unter unnu.nu

Alu Cover

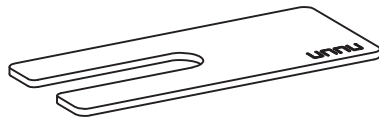

A x 1



B x 2

1

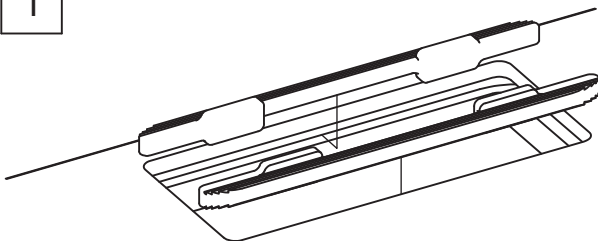

1.1

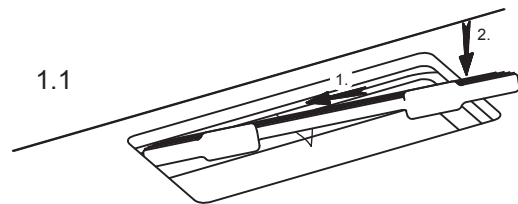

1.2

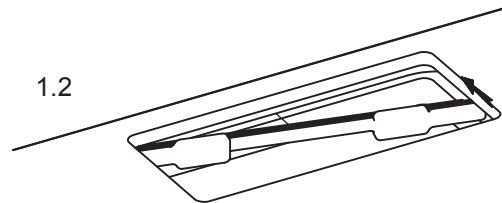

1.3

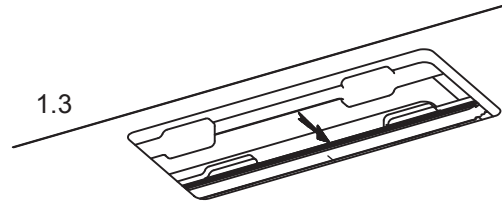

2

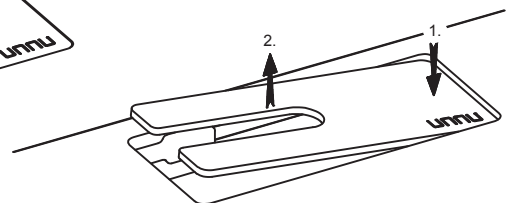
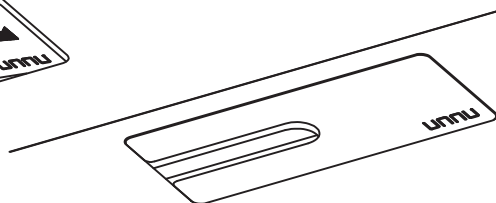
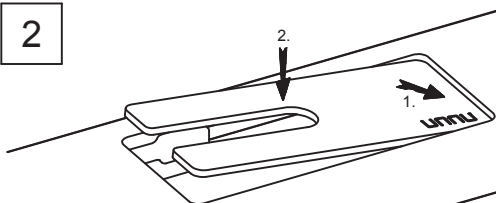

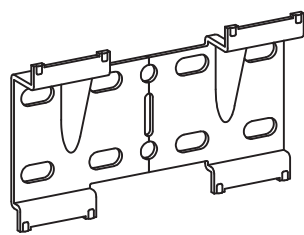
Wallbracket 3

A x 2

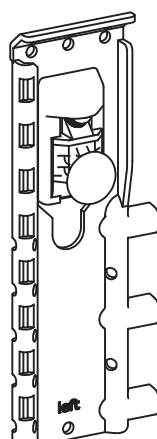

B x 2

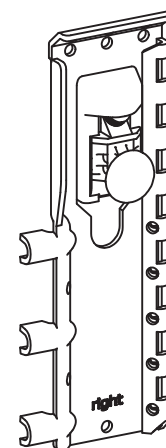

C x 2



D x 20

Nødvendige beslag

(Ikke inkluderet)

*Fittings needed**(Not included)***Benötigte Beschläge**(Nicht im Lieferumfang
enthalten)

E x 16



F x 16

Skruer og rawlplugs afhænger af vægtype, spørg en fagmand.

Screws and plugs depends on the type of wall, ask a professional.

Schrauben und Dübel müssen den baulichen Voraussetzungen angepasst werden. Fragen Sie einen Fachmann.

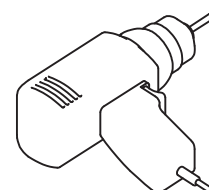
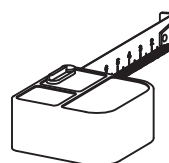
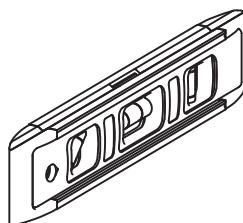
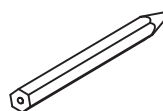
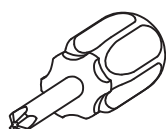
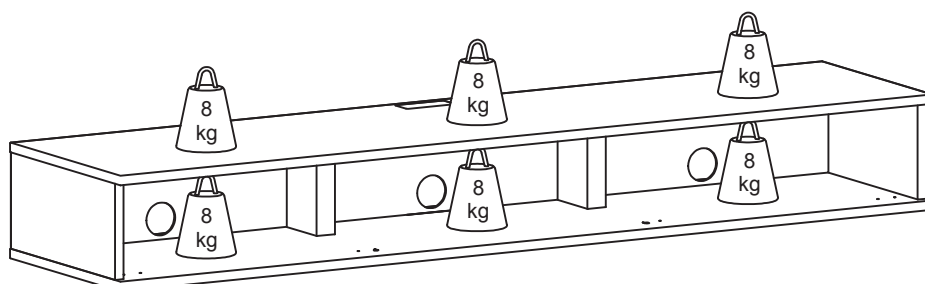
Nødvendigt værktøj*Tools needed***Benötigte Werkzeuge****Maksimal belastning***Maximum Load***Maximale Belastung**

1

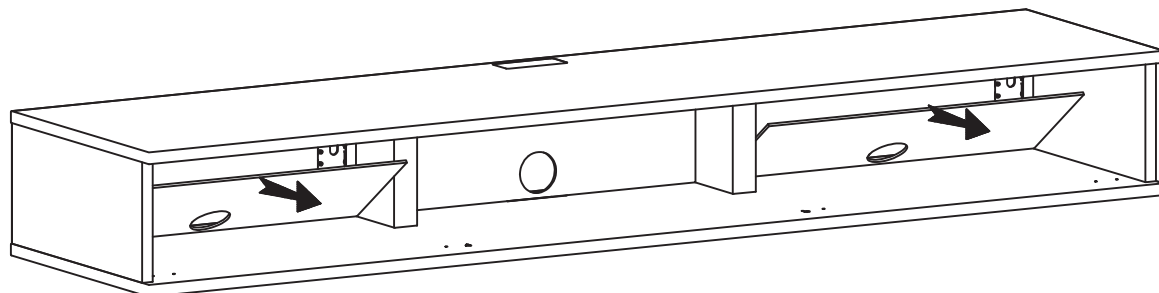

2

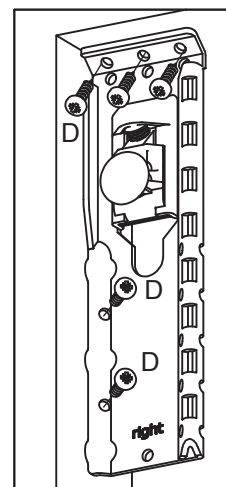
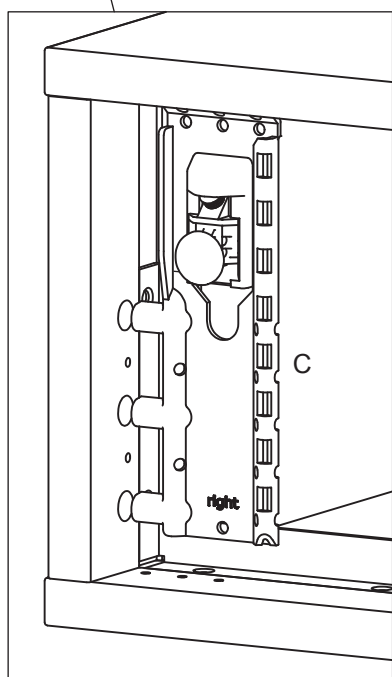
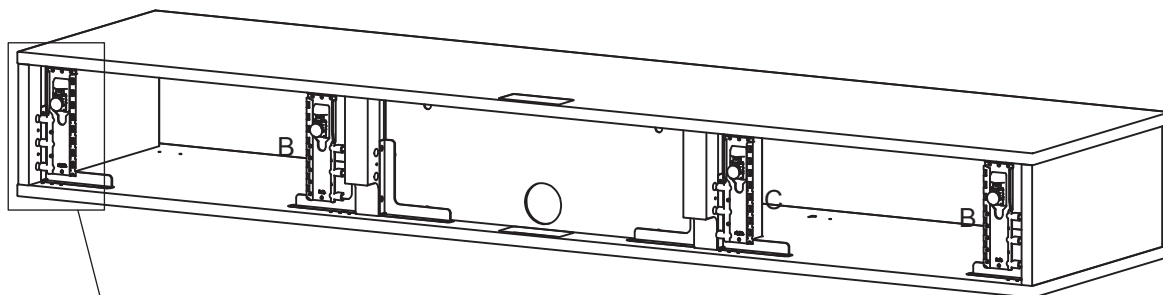

Pas på ikke at overspænde skruerne.
Be careful not to over-tighten the screws.
 Achten Sie darauf, die Schrauben nicht
 zu stark anzuziehen.

3

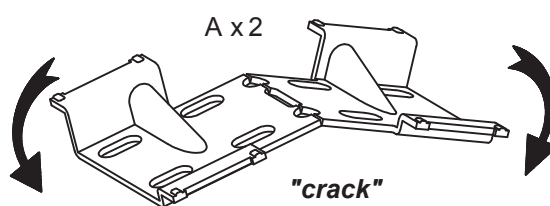

4

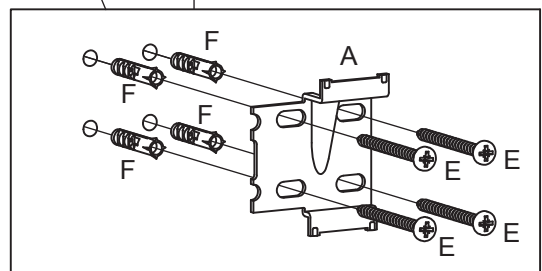
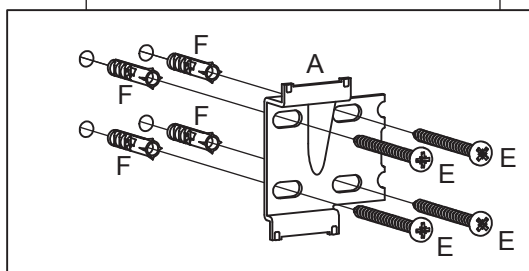
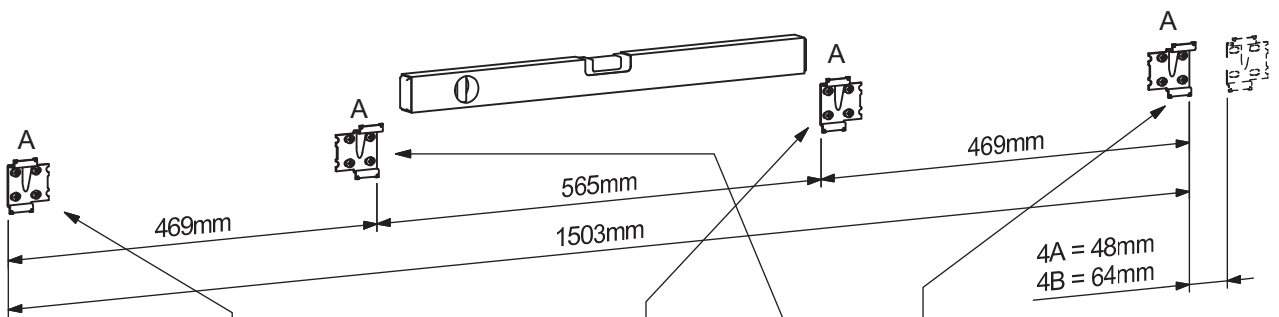
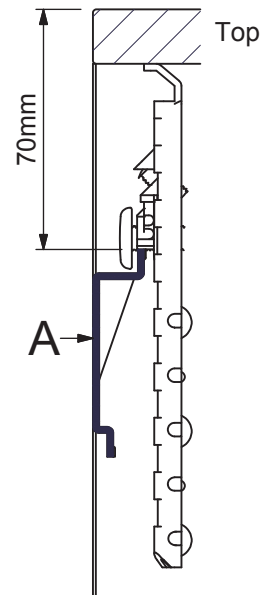
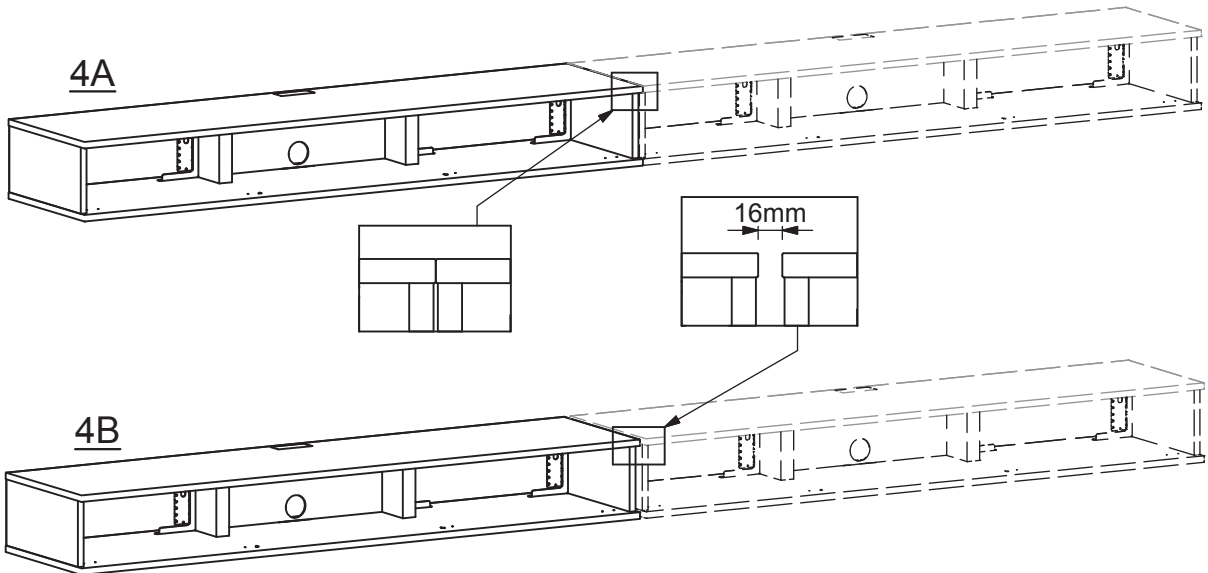

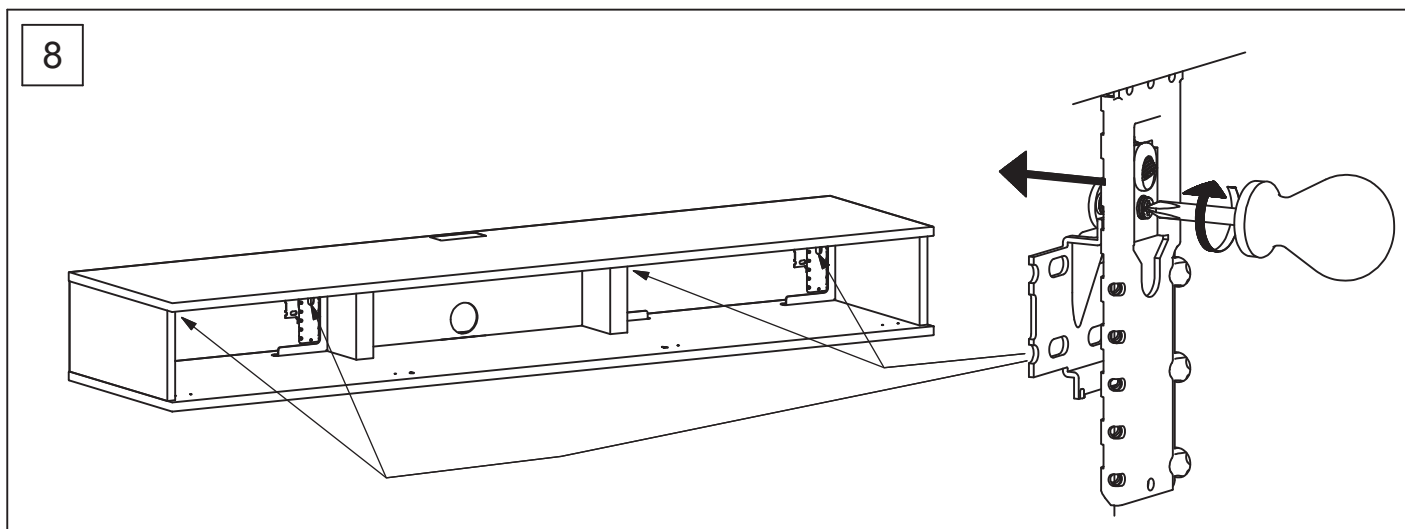
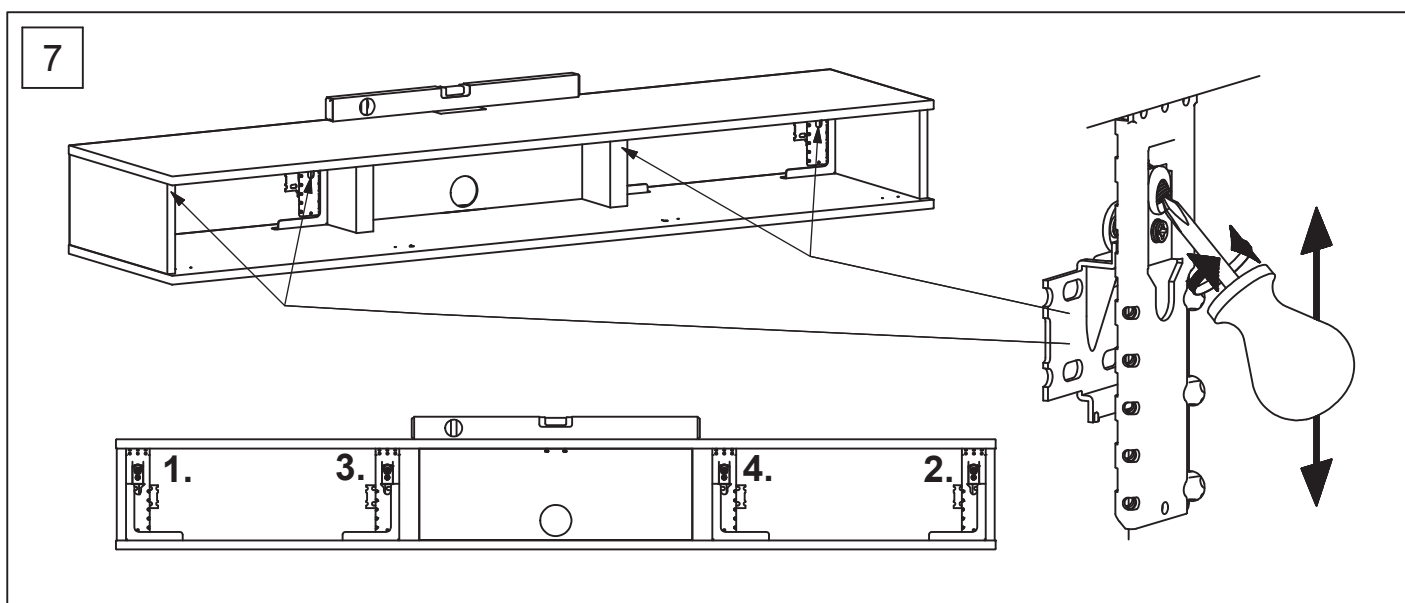
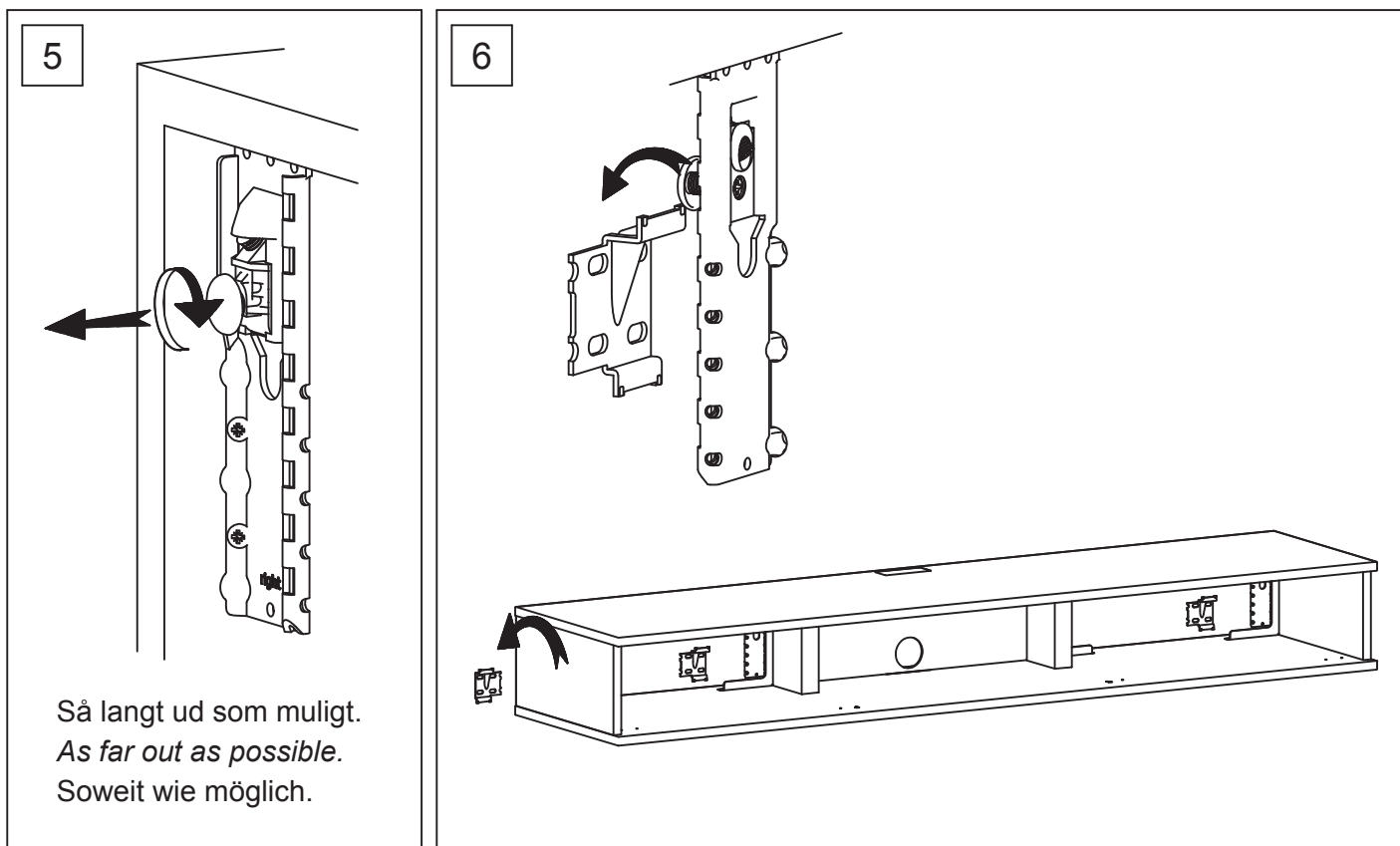

unnu Door

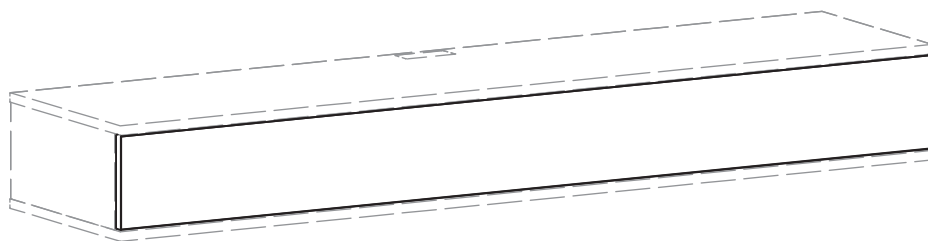

A x 1



B x 3

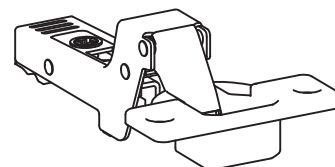

C x 3



D x 12



E x 2



F x 2

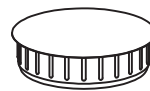

G x 2

Nødvendigt værktøj
Tools needed
Benötigte Werkzeuge

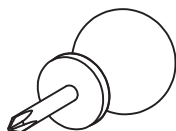

1

